

PLANTA
1:50

B

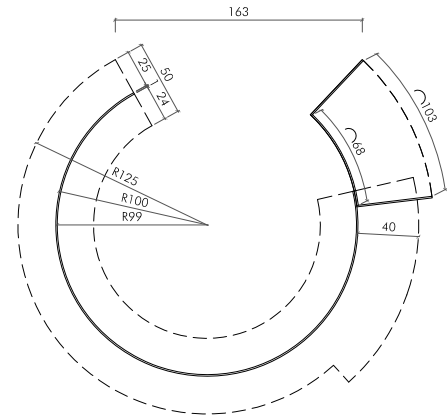

SECCIÓN H1
E1:50

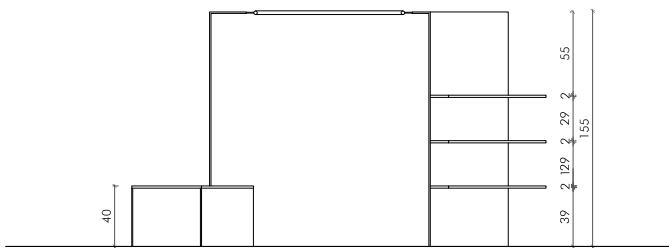

A

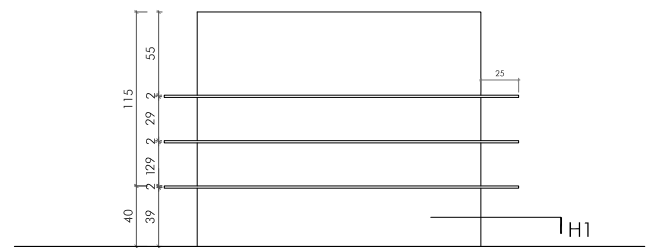

B

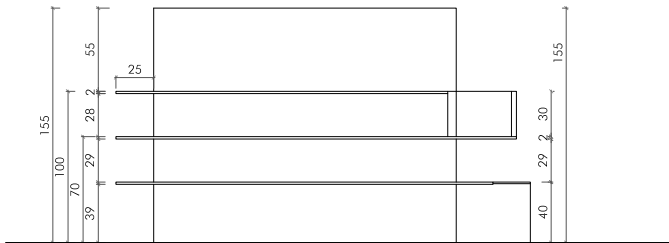

C

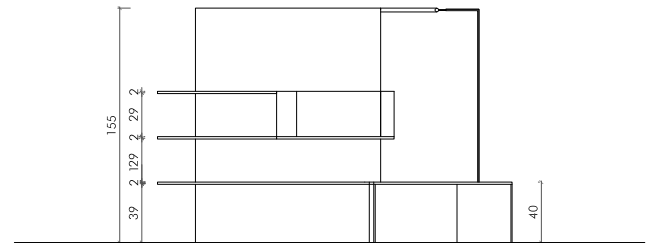

D

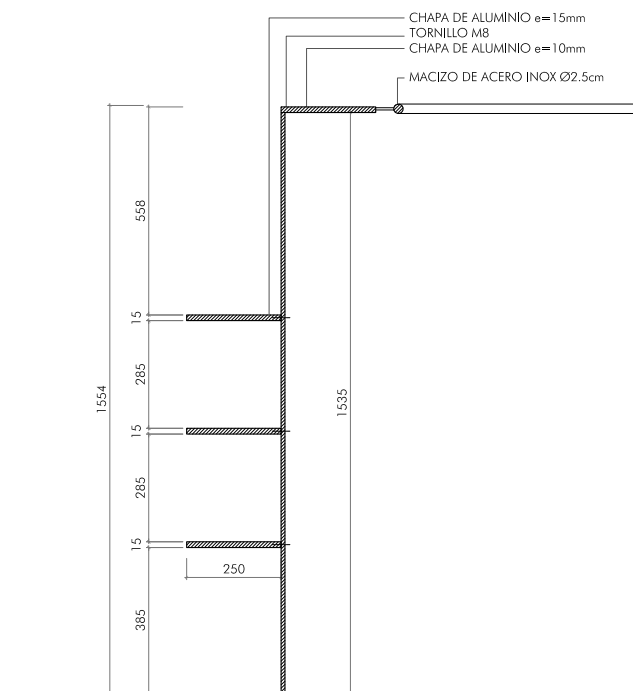

SECCIÓN V1
E 1:20

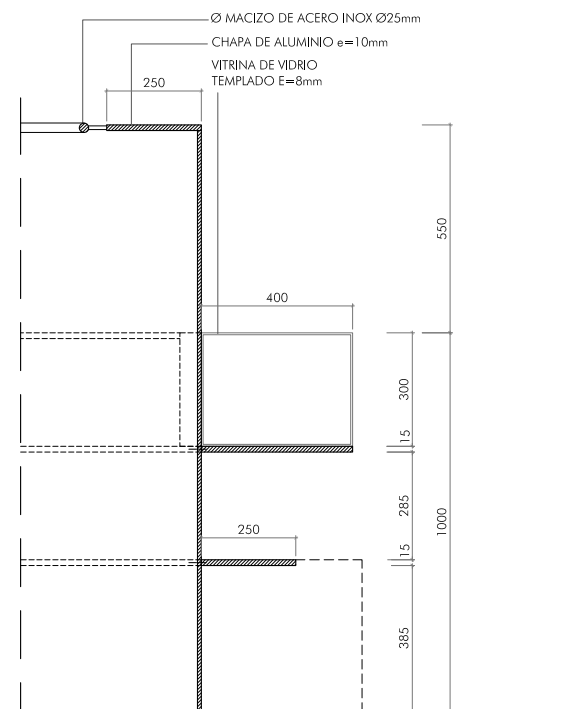

SECCIÓN V2
E 1:20

CHAPA DE ALUMINIO e=15mm
TORNILLO M8
CHAPA DE ALUMINIO e=10mm
MACIZO DE ACERO INOX Ø2.5cm

Ø MACIZO DE ACERO INOX Ø25mm
CHAPA DE ALUMINIO e=10mm
VITRINA DE VIDRIO
TEMPLADO E=8mm